

HP.AR

HP.BCR

HP.BR

HP.CR

HP.CR3

HP.SAR

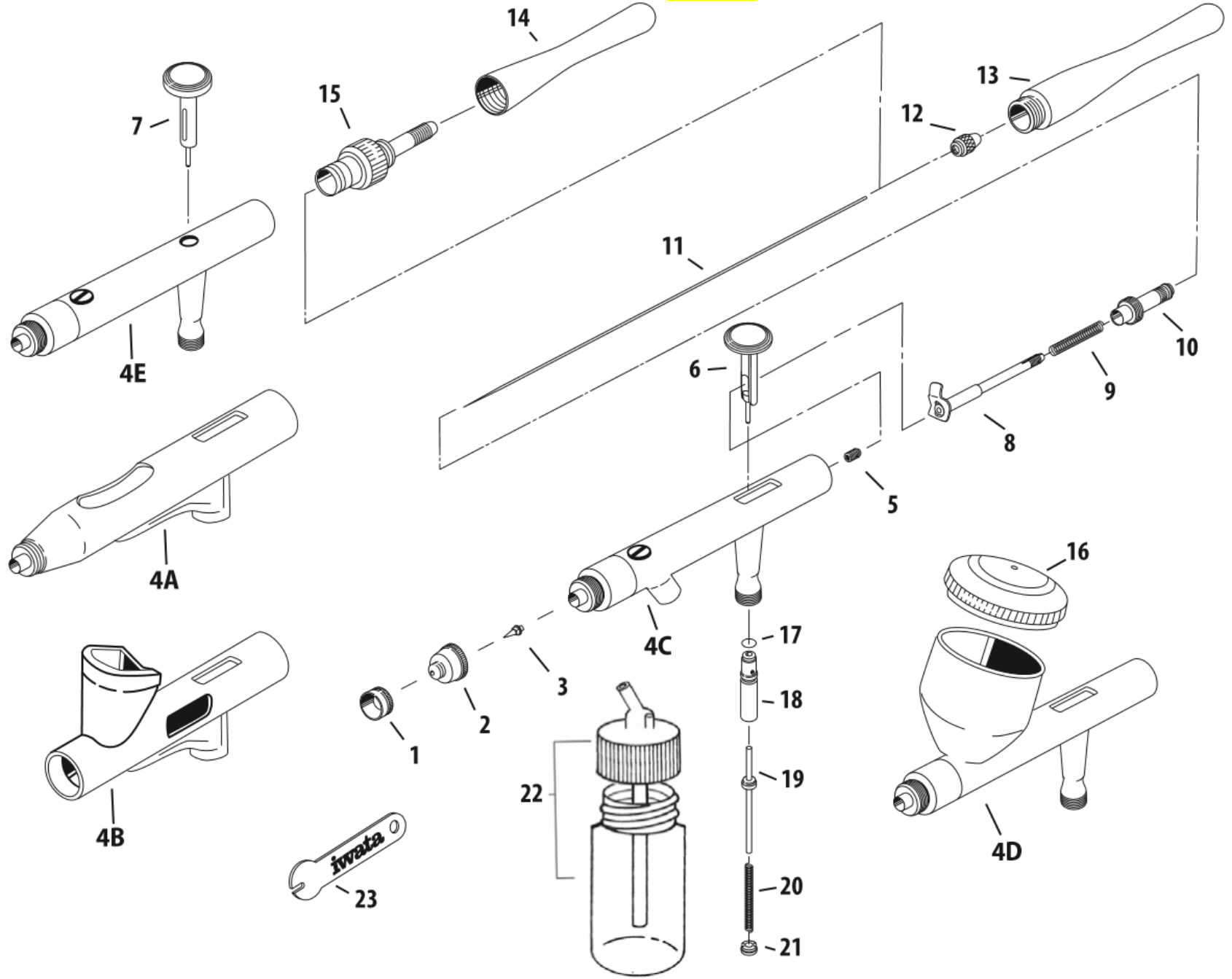

#	ITEM DESCRIPTION	ITEM #	HP-AR	HP-BR	HP-BCR	HP-CR	HP-CR3	HP-SAR	
1	Needle Cap	R3	17012	y	y	x	x	y	x
		R5	17011	x	x	y	y	x	y
2	Nozzle Cap	R3	17022	y	y	x	x	y	x
		R5	17021	x	x	y	y	x	y
3	Nozzle	R3	17042	y	y	x	x	y	x
		R5	17041	x	x	y	y	x	y
4A	HP-AR Body*	-	y	x	x	x	x	x	
4B	HP-BR Body*	-	x	y	x	x	x	x	
4C	HP-BCR Body*	-	x	x	y	x	x	x	
4D	HP-CR / HP-CR3 Body*	-	x	x	x	y	y	x	
4E	HP-SAR Body*	-	x	x	x	x	x	y	
5	Needle Packing Screw Set (PTFE)	R3	11257	y	y	x	x	y	x
		R5	17251	x	x	y	y	x	y
6	Main Lever	16121	y	y	y	y	y	x	
7	Main Lever	16122	x	x	x	x	x	y	
8	Needle Chucking Guide w/Aux Lever	11157	y	y	x	x	x	x	
		11151	-	-	y	y	y	x	

#	ITEM DESCRIPTION	ITEM #	HP-AR	HP-BR	HP-BCR	HP-CR	HP-CR3	HP-SAR	
9	Needle Spring	1351	y	y	y	y	y	x	
10	Spring Guide	17701	y	y	y	y	y	x	
11	Needle	R5	17171	x	x	y	y	x	y
		R3	17173	y	y	x	x	y	x
12	Needle Chucking Nut	11201	y	y	y	y	y	y	
13	Ergonomic Handle	17191	y	y	y	y	y	x	
	Preset Handle	11552	OPT	OPT	OPT	OPT	OPT	x	
	Preset Cutaway Handle	11556	OPT	OPT	OPT	OPT	OPT	x	
14	Ergonomic Handle	17192	x	x	x	x	x	y	
15	Fluid Adjustment Knob	17221	x	x	x	x	x	y	
16	Lid	17181	x	x	x	y	y	x	
17	Air Valve O-ring	15801	y	y	y	y	y	y	
18	Valve Guide Body	16081	y	y	y	y	y	y	
19	Air Valve	16091	y	y	y	y	y	y	
20	Air Valve Spring	10351	y	y	y	y	y	y	
21	Air Valve Guide Screw	17111	y	y	y	y	y	y	
22	Bottle 1 oz / 30 ml	A4701	x	x	y	x	x	y	
23	Spanner	17651	y	y	y	y	y	y	
y = yes x = no OPT = Optional									